

Bañera de encastre / Inset bathtub / Baignoire encastrée / Banheira incorporada / Vasca da bagno integrata  
sanitaryacrylic



Acabados / Finishes / Finition / Acabamento / Finitura



WG

Blanco brillo  
Gloss white  
Blanc brillant  
Branco brilho  
Bianco lucido

Medidas / Measures / Mesures / Medidas / Misure

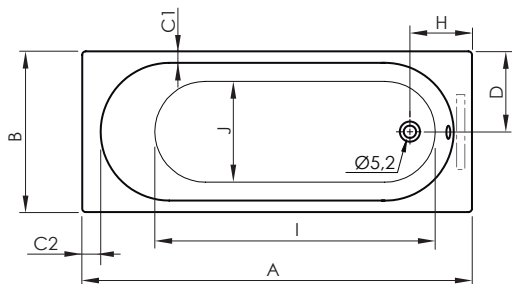
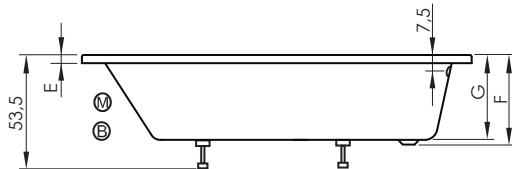

P: Peso neto / Net weight / Poids net / Peso líquido / Peso netto

P': Peso de expedición / Expedition Weight / Poids d'expédition / Peso do expedição / Peso spedizione

V: Volumen de expedición / Expedition Volume / Volume d'expédition / Volume do expedição / Volume spedizione

CA: Contenido agua / Water content / Contenu d'eau / Conteúdo de água / Contenuto acqua

**M** Motor / Pump / Motore / Motor / Pompe

**B** Blower / Blower / Blower / Blower / Blower

cm  
+/-0,5

ref.	dim.	A	B	C1	C2	D	E	F	G	H	I	J	P kg	P' kg	V cmxcmxcm	CA L
BN118	140x70	140	70	5	8	35	3,5	40	37	27,5	92	44	14,5	15,5	150 x 75 x 41	127
BN118	150x70	150	70	5	8	35	3,5	40	37	27,5	101	44	15,5	16,5	160 x 75 x 41	140
BN118	160x70	160	70	5	8	35	3,5	40	37	27,5	112	44	16,5	17,5	170 x 75 x 41	146
BN118	160x75	160	75	5	8	37,5	3,5	40	37	27,5	112	47	18	19	170 x 80 x 41	150
BN118	170x70	170	70	5	8	35	3,5	40	37	27,5	122	44	18	19	180 x 75 x 41	157
BN118	170x75	170	75	5	8	37,5	3,5	40	37	27,5	122	47	20,5	21,5	180 x 80 x 41	184
BN118	180x80	180	80	5	8	40	3,5	40	37	27,5	132	50	23	24	190 x 85 x 41	200

Grifería / Taps / Robinets / Torneiras/ Rubinetti



Loop



Loop K



Kali

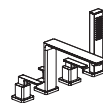

Cubo

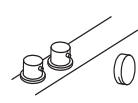
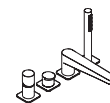

Posición habitual de la grifería  
Usual tap position  
Position commune du robinet  
Posição usual da torneira  
Posizione del rubinetto

Posición habitual de la grifería Usual tap position  
Position commune du robinet  
Posição usual da torneira  
Posizione del rubinetto

Preinstalación / Preinstallation / Pré-installation / Pré-instalação / Preinstalacion

A pared / To wall / À mur / A muro / A parete

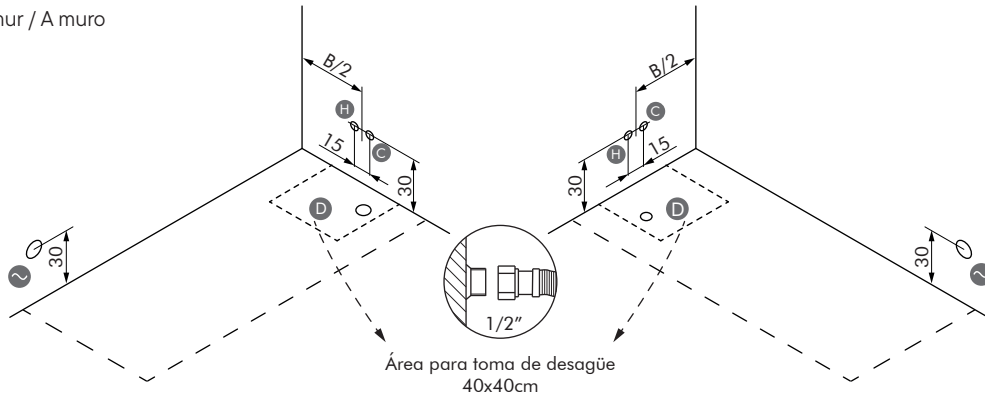

Encastre / Built-in / Encastrée / Encastré / Encastre

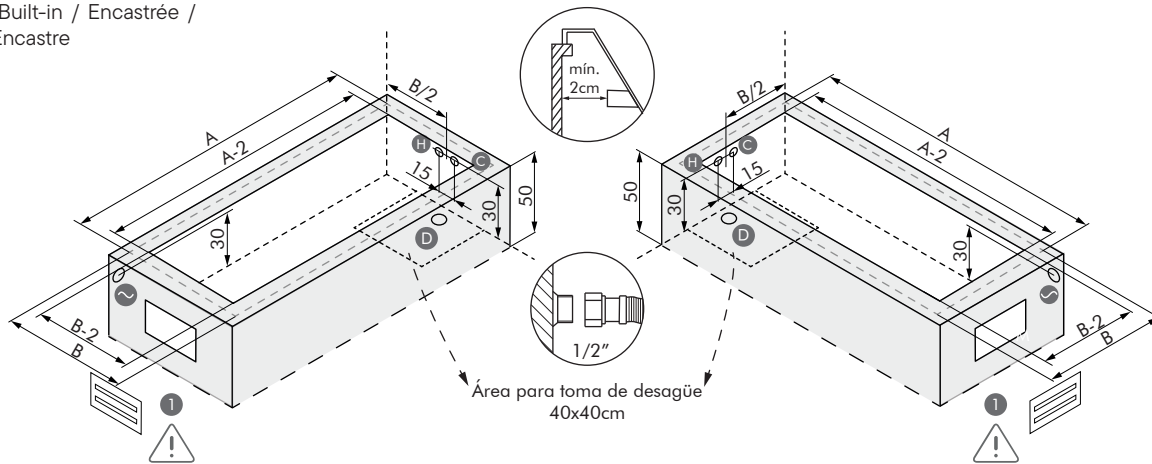

Exenta / Freestanding / En îlot / Freestanding / Centrostanza

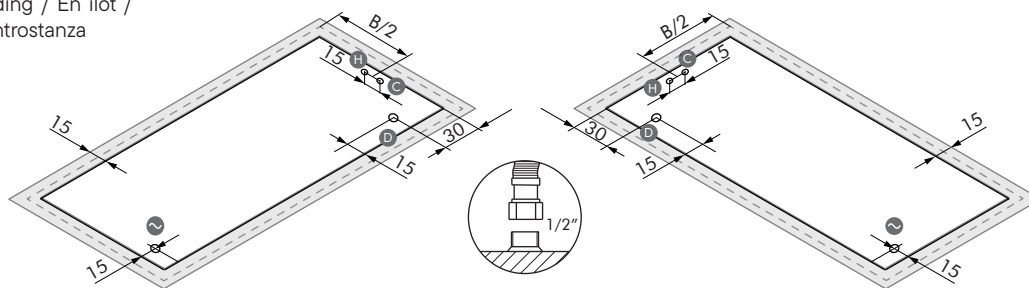

- D** Desagüe / Waste / Bonde / Drenagem / Scarico
- C** Agua fría / Cold water / Eau froide / Água fria / Acqua fredda
- H** Agua caliente / Hot water / Eau chaude / Água quente / Acqua calda
- S** Toma corriente / Power outlet / Prise électrique / Tomada eléctrica / Presa di corrente

Área para grifería exenta / Area for freestanding tap / Zone pour robinet exemptés / Área para torneira isentas / Area per rubinetti esenti

- !** **1** Registro removible para ventilación, dimensión mínima 30x30cm. Para todas las bañeras con hidromasaje. Removable register for ventilation, minimum dimension 30x30cm. For all hydromassage bathtubs. Registre amovible pour ventilation, dimension minimum 30x30cm. Pour toutes les baignoires d'hydromassage. Registro removível para ventilação, dimensão mínima 30x30cm. Para todas as banheiras de hidromassagem. Registro smontabile per ventilazione, dimensione minima 30x30cm. Per tutte le vasche idromassaggio.

COMPONENTES / COMPONENTS / COMPOSANTS / COMPONENTES / COMPONENTI		EQUIPAMIENTO / EQUIPMENT / ÉQUIPEMENT / EQUIPAMENTO / EQUIPAGGIAMENTO				
		Confort	T Confort	B Confort	DS Confort	Elegance
Motor hidro / Pump / Pompe hydro/ Bomba hidráulica / Pompa		●	●		●	●
Jets hidro / Jets hidro / Buses hydro/ Jatos hidro / Getto hidro	< 170 cm	6	6		6	8
	≥ 170 cm					10
Blower / Blower / Blower / Blower / Blower				●	●	●
Jets blower / Jets blower / Buses blower / Jatos blower / Getto blower	< 170 cm			8	8	8
	≥ 170 cm			10	10	10
Focos cromoterapia LED / LED cromotherapy focus / Foyers chromothérapie LED / Focos cromoterapia LED / Foci cromoterapia LED	< 170 cm					8
	≥ 170 cm					10
Pulsador neumático / Pneumatic push / Commande pneumatique / Botão pneumático / Spinta pneumatica		●				
Regulador de aire / Air regulator / Variateur d'air manuel / Air regulador / Regulatore aria		●				
Pulsador on-off cristal / On-off push glass / Commande on-off cristal / Botão on-off do vidro / Spinta on-off cristallo						●
Boca de aspiración / Suction mouth / Bouche de succion / Boca de aspiração / Bocca di aspirazione		●	●		●	●
Sensor de nivel / Sensor level / Détecteur de niveau / Sensor de nível / Sensore di livello			●	●	●	●
Sistema autovaciado del blower / Self-emptying blower system / Système auto-vidange «blower» / Sistema auto-esvaziamento do blower / Sistema auto-svuotamento di blower				●	●	●
Peso kit / Kit weight / Poids kit / Peso kit / Peso kit (kg)		13	14	7,5	19	19
U (V)		230	230	230	230	230
F (Hz)		50	50	50	50	50
P (KW)		0,370	0,560	0,400	1,150	1,150
Nivel acústico / Acoustic level / Niveau sonore / Nivel de som / Livello sonoro (dB)		49	49	52	52	52



SH



B Confort



Confort



DS Confort





T Confort



Elegance

Izquierda / Left / Gauche / Esquerda / Sinistra

Accesorios / Accesories / Accesories / Acessórios / Accessori

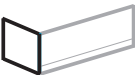
Paneles / Panels / Tabliers / Painéis / Pannelli	dim. cm	 Acrílico / Acrylic / Acrilique/ Acrílico / Acrilico	H cm
* 	140	FALREC140	50
	150	FALREC150	50
	160	FALREC160	50
	170	FALREC170	50
	180	FALREC180	50
* 	70	FALLAT70	50
	75	FALLAT75	50
	80	FALLAT80	50

- \* Los faldones acrílicos permiten cubrir un máximo de tres lados, uno largo y dos cortos  
 Acrylic panels allow covering maximum three sides, one long side and two short sides  
 Les tabliers acryliques permettent la couverture sur trois côtés maximum, un côté long et deux côtés courts  
 Abas da tampa de acrílico permitem um máximo de três lados, um longo e dois curtos  
 Flaps copertura acrilica consentono un massimo di tre lati, uno lungo e due brevi